



MAQ3203

High-Brightness LED Driver Controller with High-Side Current Sense

General Description

The MAQ3203 is a hysteretic, step-down, constant-current, High-Brightness LED (HB LED) driver. It provides an ideal solution for interior/exterior lighting, architectural and ambient lighting, LED bulbs, and other general illumination applications.

The MAQ3203 is well suited for lighting applications requiring a wide-input voltage range. The hysteretic control gives good supply rejection and fast response during load transients and PWM dimming. The high-side current sensing and on-chip current-sense amplifier delivers LED current with $\pm 5\%$ accuracy. An external high-side current-sense resistor is used to set the output current.

The MAQ3203 offers a dedicated PWM input (DIM) which enables a wide range of pulsed dimming. A high-frequency switching operation up to 1.5MHz allows the use of smaller external components minimizing space and cost. The MAQ3203 offers frequency dither feature for EMI control.

The MAQ3203 operates over a junction temperature from -40°C to $+125^{\circ}\text{C}$ and is available in an 8-pin SOIC package. The MAQ3203 is AEC-Q100 qualified for automotive applications.

Datasheets and support documentation can be found on Micrel's web site at: www.micrel.com.



Features

- AEC-Q100 qualified
- 4.5V to 42V input voltage range
- High efficiency ($>90\%$)
- $\pm 5\%$ LED current accuracy
- Dither enabled for low EMI
- High-side current sense
- Dedicated dimming control input
- Hysteretic control (no compensation!)
- Up to 1.5MHz switching frequency
- Adjustable constant LED current
- Over-temperature protection
- -40°C to $+125^{\circ}\text{C}$ junction temperature range

Applications

- Automotive lighting
- Industrial lighting

Typical Application

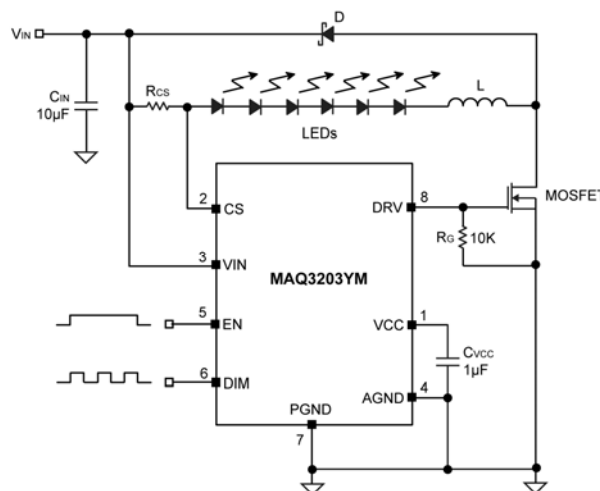

MAQ3203 Step-down LED Driver

www.DataSheet4U.com

Ordering Information ⁽¹⁾

Part Number	Marking	Junction Temperature Range	Package	PWM
MAQ3203YM	MAQ3203YM	-40°C to +125°C	8-Pin SOIC	Dither

Note:

1. YM[®] is a GREEN RoHS compliant package. Lead finish is NiPdAu. Mold compound is Halogen Free.

Pin Configuration

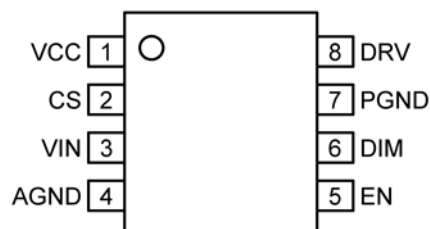

8-Pin SOIC
MAQ3203

Pin Description

Pin Number	Pin Name	Pin Function
1	VCC	Voltage Regulator Output. The V _{CC} pin supplies the power to the internal circuitry. The VCC in the output of a linear regulator which is powered from VIN. A 1μF ceramic capacitor is recommended for bypassing and should be placed as close as possible to the VCC and AGND pins. Do not connect to an external load.
2	CS	Current-Sense Input. The CS pin provides the high-side current sense to set the LED current with an external sense resistor.
3	VIN	Input Power Supply. VIN is the input supply pin to the internal circuitry and the positive input to the current sense comparator. Due to the high frequency switching noise, a 10μF ceramic capacitor is recommended to be placed as close as possible to VIN and the power ground (PGND) pin for bypassing. Please refer to layout recommendations.
4	AGND	Ground pin for analog circuitry. Internal signal ground for all low power sections.
5	EN	Enable Input. The EN pin provides a logic level control of the output and the voltage has to be 2.0V or higher to enable the current regulator. The output stage is gated by the DIM pin. When the EN pin is pulled low, the regulator goes to off state and the supply current of the device is greatly reduced (below 1μA). In the off state, during this period the output drive is placed in a "tri-stated" condition, where MOSFET is in an "off" or non-conducting state. Do not drive the EN pin above the supply voltage.
6	DIM	PWM Dimming Input. The DIM pin provides the control for brightness of the LED. A PWM input can be used to control the brightness of LED. DIM high enables the output and its voltage has to be at least 2.0V or higher. DIM low disables the output, regardless of EN "high" state.
7	PGND	Power Ground Pin for Power FET. Power Ground (PGND) is for the high-current switching with hysteretic mode. The current loop for the power ground should be as small as possible and separate from the Analog ground (AGND) loop. Refer to the layout considerations for more details.
8	DRV	Gate-Drive Output. Connect to the gate of an external N-channel MOSFET. The drain of the external MOSFET connects directly to the inductor and provides the switching current necessary to operate in hysteretic mode. Due to the high frequency switching and high voltage associated with this pin, the switch node should be routed away from sensitive nodes.

Absolute Maximum Ratings ⁽¹⁾

V _{IN} to PGND	-0.3V to +45V
V _{CC} to PGND	-0.3V to +6.0V
CS to PGND	-0.3V to (V _{IN} + 0.3V)
EN to AGND	-0.3V to (V _{IN} + 0.3V)
DIM to AGND	-0.3V to (V _{IN} + 0.3V)
DRV to PGND	-0.3V to (V _{CC} + 0.3V)
PGND to AGND	-0.3V to + 0.3V
Junction Temperature	150°C
Storage Temperature Range	-60°C to +150°C
Lead Temperature (Soldering, 10sec)	260°C
ESD Ratings ⁽³⁾	
HBM	1.5kV
MM	200V

Operating Ratings ⁽²⁾

Supply Voltage (V _{IN})	4.5V to 42V
Enable Voltage (V _{EN})	0V to V _{IN}
Dimming Voltage (V _{DIM})	0V to V _{IN}
Junction Temperature (T _J)	-40°C to +125°C
Junction Thermal Resistance	
SOIC (θ _{JA})	98.9°C/W
SOIC (θ _{JC})	48.8°C/W

Electrical Characteristics ⁽⁴⁾

V_{IN} = V_{EN} = V_{DIM} = 12V; C_{VCC} = 1.0μF; T_J = 25°C, **bold** values indicate -40°C ≤ T_A ≤ +125°C; unless noted.

Symbol	Parameter	Condition	Min.	Typ.	Max.	Units
Input Supply						
V _{IN}	Input Voltage Range (V _{IN})		4.5		42	V
I _S	Supply Current	DRV = open		1	3	mA
I _{SD}	Shutdown Current	V _{EN} = 0V			1	μA
UVLO	V _{IN} UVLO Threshold	V _{IN} rinsing	3.2	4	4.5	V
UVLO _{HYS}	V _{IN} UVLO Hysteresis			500		mV
VCC Supply						
VCC	V _{CC} Output Voltage	V _{IN} = 12V, I _{CC} = 10mA	4.5	5	5.5	V
Current Limit						
V _{CS(MAX)}	Current Sense Upper Threshold	V _{CS(MAX)} = V _{IN} - V _{CS}	201.4	212	222.6	mV
			199	212	225	mV
V _{CS(MIN)}	Sense Voltage Threshold Low	V _{CS(MIN)} = V _{IN} - V _{CS}	168	177	186	mV
			165	177	189	mV
V _{CSHYS}	V _{CS} Hysteresis			35		mV
	Current Sense Response Time	V _{CS} Rising		50		ns
		V _{CS} Falling		70		ns
	CS Input Current	V _{IN} - V _{CS} = 220mV		0.5	10	μA
Frequency						
F _{MAX}	Switching Frequency				1.5	MHz
Dithering (MAQ3203)						
V _{DITH}	V _{CS} Hysteresis Dithering Range ⁽⁵⁾			±6		mV
F _{DITHER}	Frequency Dithering Range ⁽⁵⁾	% of Switching Frequency		±12		%

Electrical Characteristics ⁽⁴⁾ (Continued)

$V_{IN} = V_{EN} = V_{DIM} = 12V$; $C_{VCC} = 1.0\mu F$; $T_J = 25^\circ C$, **bold** values indicate $-40^\circ C \leq T_J \leq +125^\circ C$; unless noted.

Symbol	Parameter	Condition	Min.	Typ.	Max.	Units
Enable Input						
EN _{HI}	EN Logic Level High		2.0			V
EN _{LO}	EN Logic Level Low				0.4	V
	EN Bias Current	$V_{EN} = 12V$			60	μA
		$V_{EN} = 0V$			1	μA
	Start-Up Time	From EN Pin going high to DRV going high		30		μs
Dimming Input						
DIM _{HI}	DIM Logic Level High		2.0			V
DIM _{LO}	DIM Logic Level Low				0.4	V
	DIM Bias Current			20	50	μA
		$V_{DIM} = 0V$			1	
	DIM Delay Time	From DIM Pin going high to DRV going high		450		ns
F _{DIM}	Maximum Dimming Frequency				20	kHz
External FET Driver						
	DRV On-Resistance	Pull Up, $I_{SOURCE} = 10mA$		2		Ω
		Pull Down, $I_{SINK} = -10mA$		1.5		
	DRV Transition Time	Rise Time, $C_{LOAD} = 1000pF$		13		ns
		Fall Time, $C_{LOAD} = 1000pF$		7		
Thermal Protection						
T _{LIM}	Over-Temperature Shutdown	T _J Rising		160		$^\circ C$
T _{LIMHYS}	Over-Temperature Shutdown Hysteresis			20		

Notes:

1. Exceeding the absolute maximum rating may damage the device.
2. The device is not guaranteed to function outside its operating rating.
3. Devices are ESD sensitive. Handling precautions recommended. Human body model, 1.5k in series with 100pF.
4. Specification for packaged product only.
5. Guaranteed by design.

Typical Characteristics

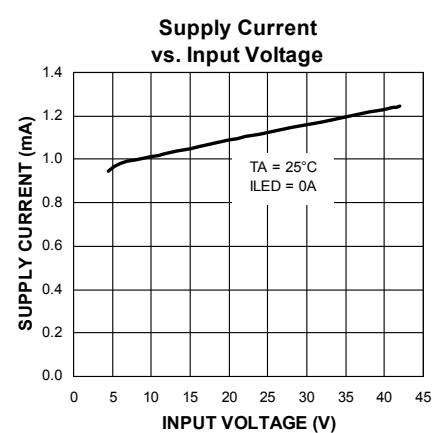
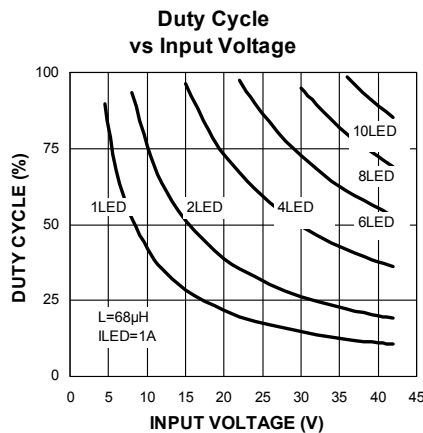
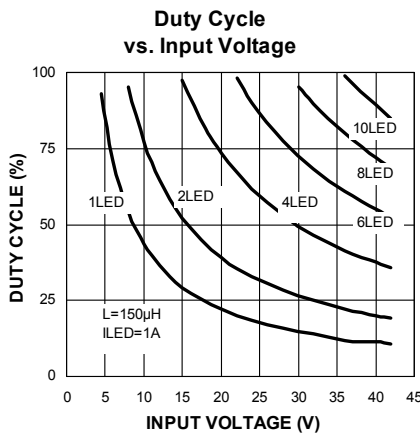
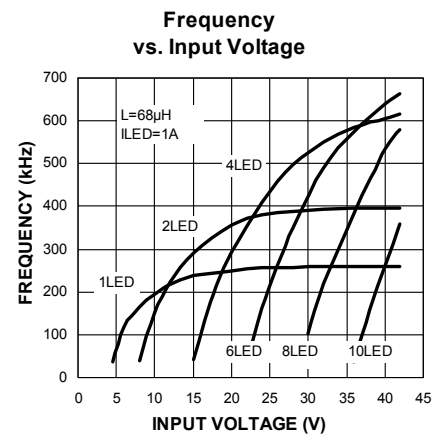
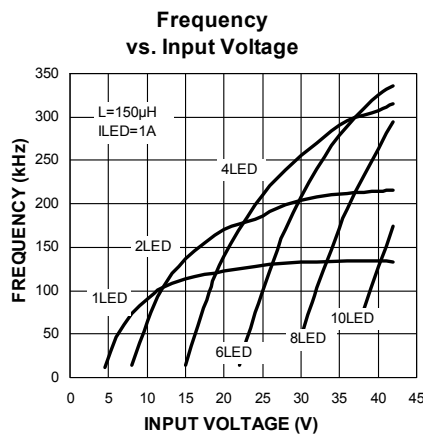
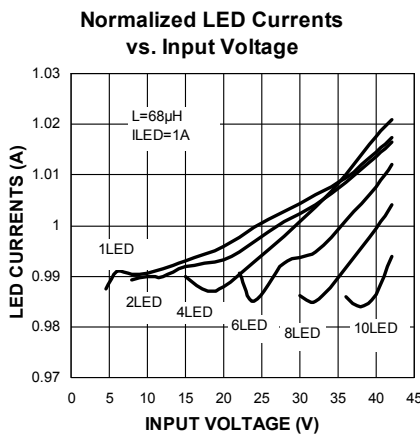
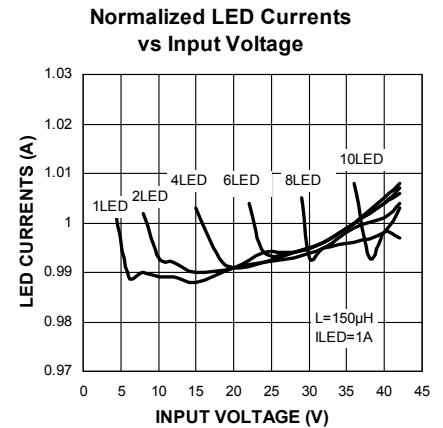
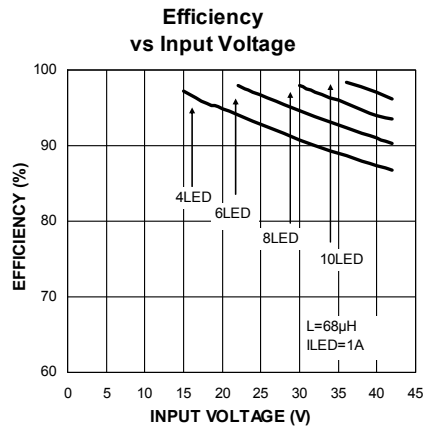
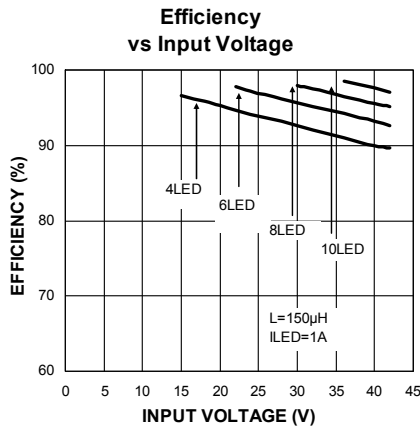

Typical Characteristics (Continued)

VCC vs. Input Voltage

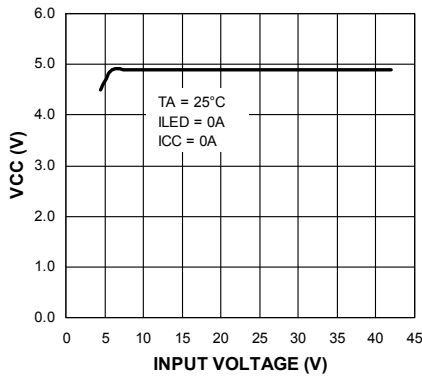

Enable Threshold vs. Input Voltage

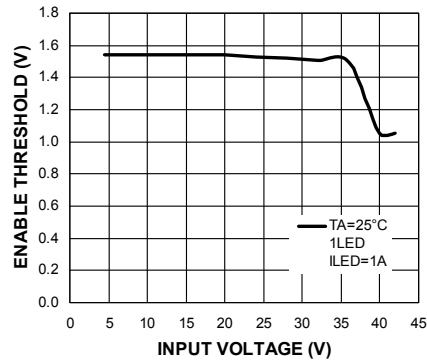

Current-Sense Voltage vs. Input Voltage

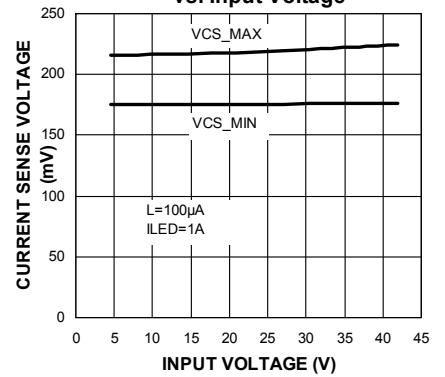

Shutdown Current vs. Input Voltage

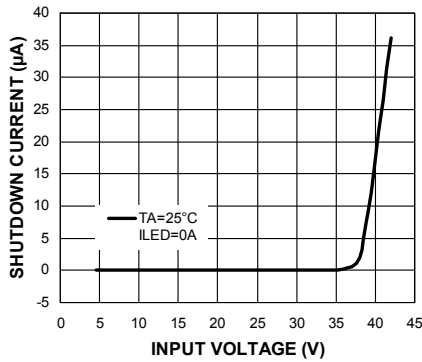

Enable Current vs. Enable Voltage

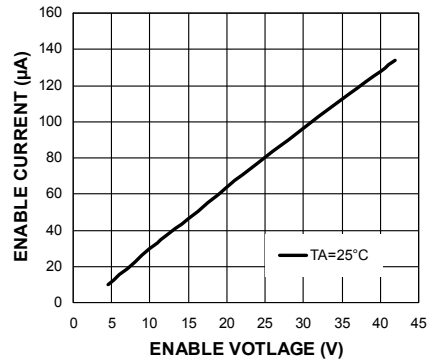

ICC Limit vs. Input Voltage

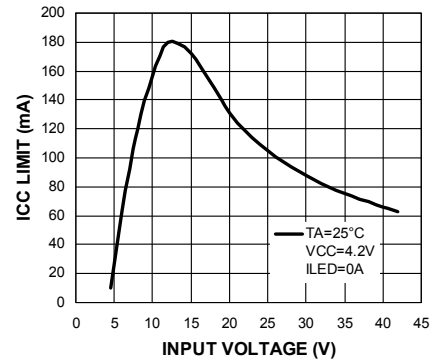

Supply Current vs. Temperature

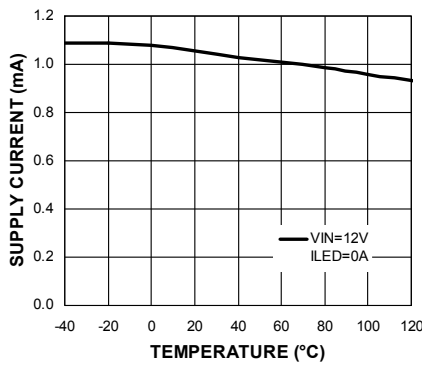

VCC vs. Temperature

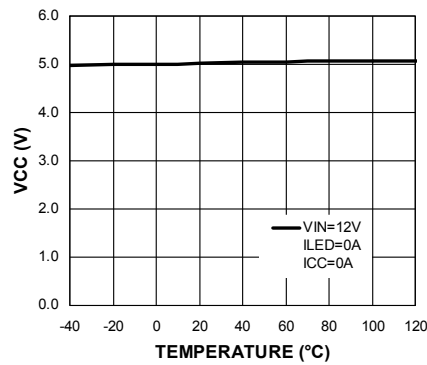

Enable Threshold vs. Temperature

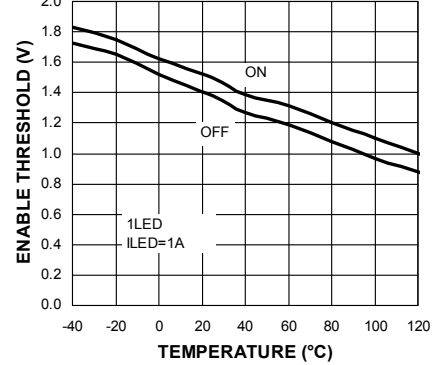

Typical Characteristics (Continued)

Shutdown Current vs. Temperature

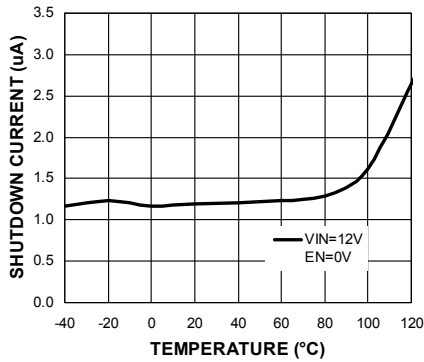

Enable Current vs. Temperature

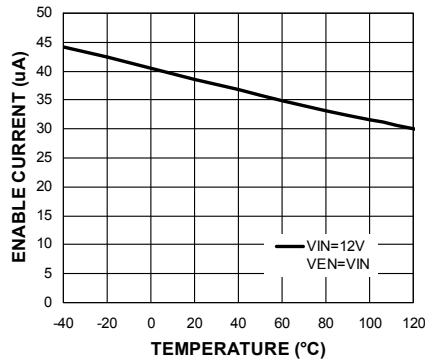

Current-Sense Voltage vs. Temperature

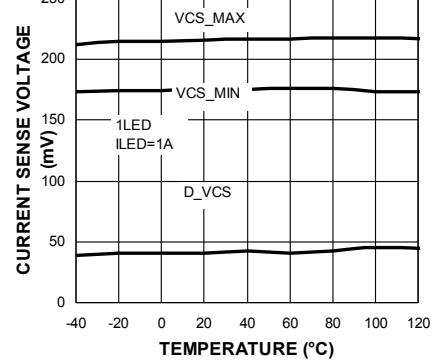

Switching Frequency vs. Temperature

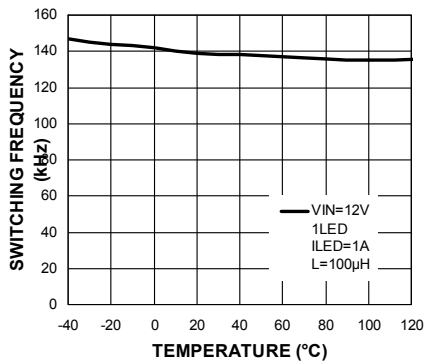

UVLO Threshold vs. Temperature

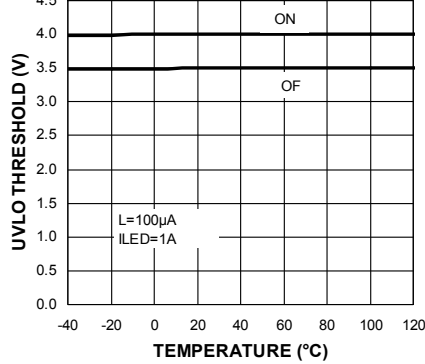

Thermal Shutdown vs. Input Voltage

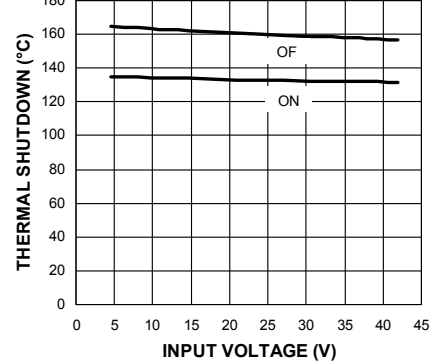

Functional Characteristics

**Steady-State Operation
@ VIN = 6V**

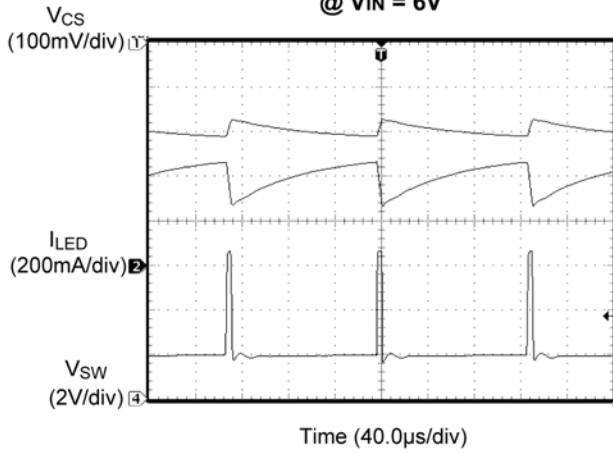

**PWM Dimming @ 20kHz
(10% Duty Cycle)**

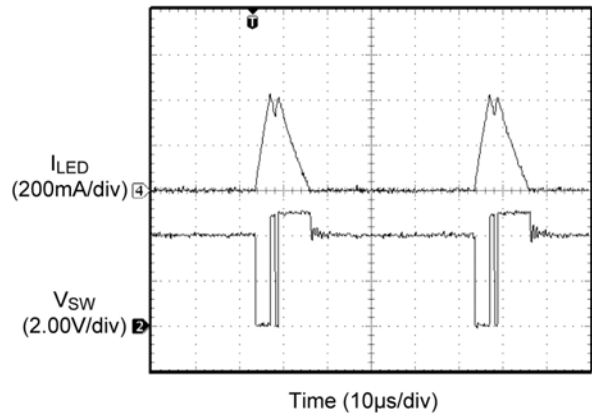

**Steady-State Operation
@ VIN = 12V**

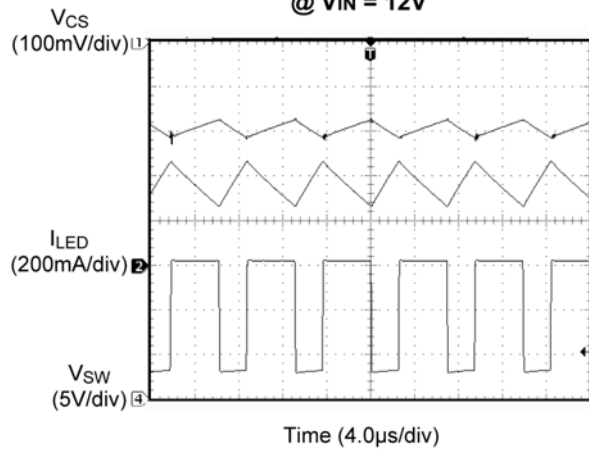

**PWM Dimming @ 20kHz
(90% Duty Cycle)**

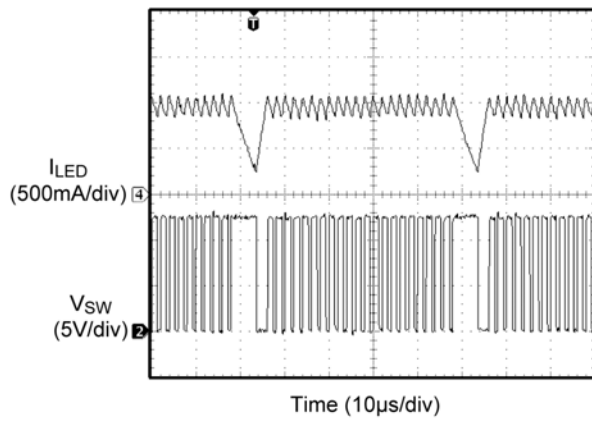

**Steady-State Operation
@ VIN = 24V**

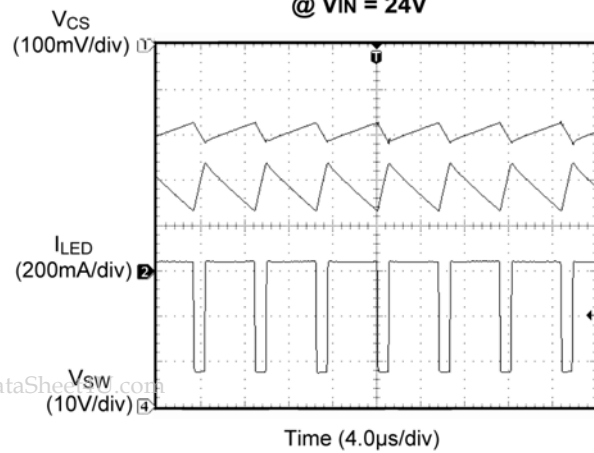

**PWM Dimming @ 20kHz
(10% Duty Cycle)**

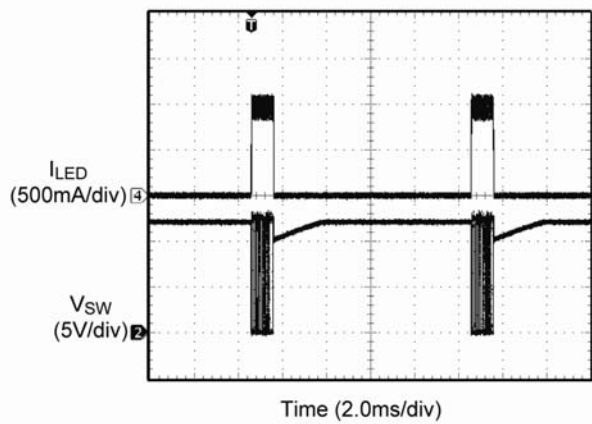

www.DataSheet4U.com

Functional Characteristics (Continued)

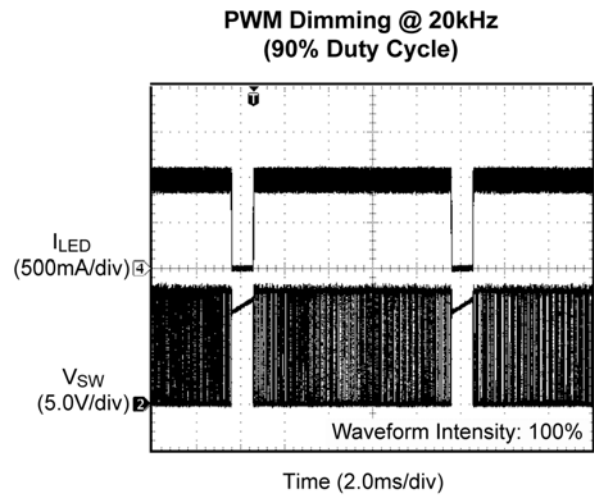
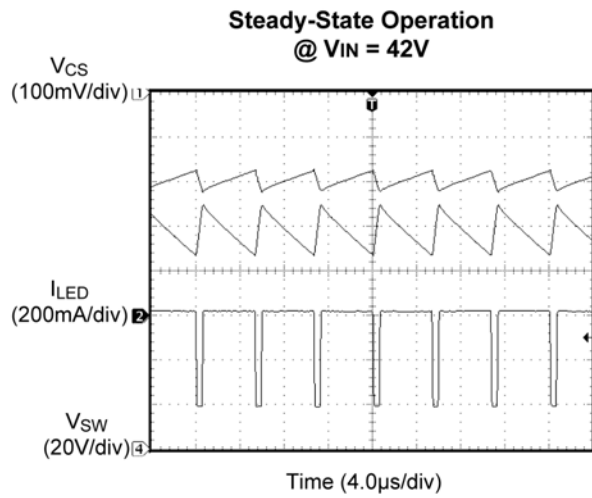

Functional Diagram

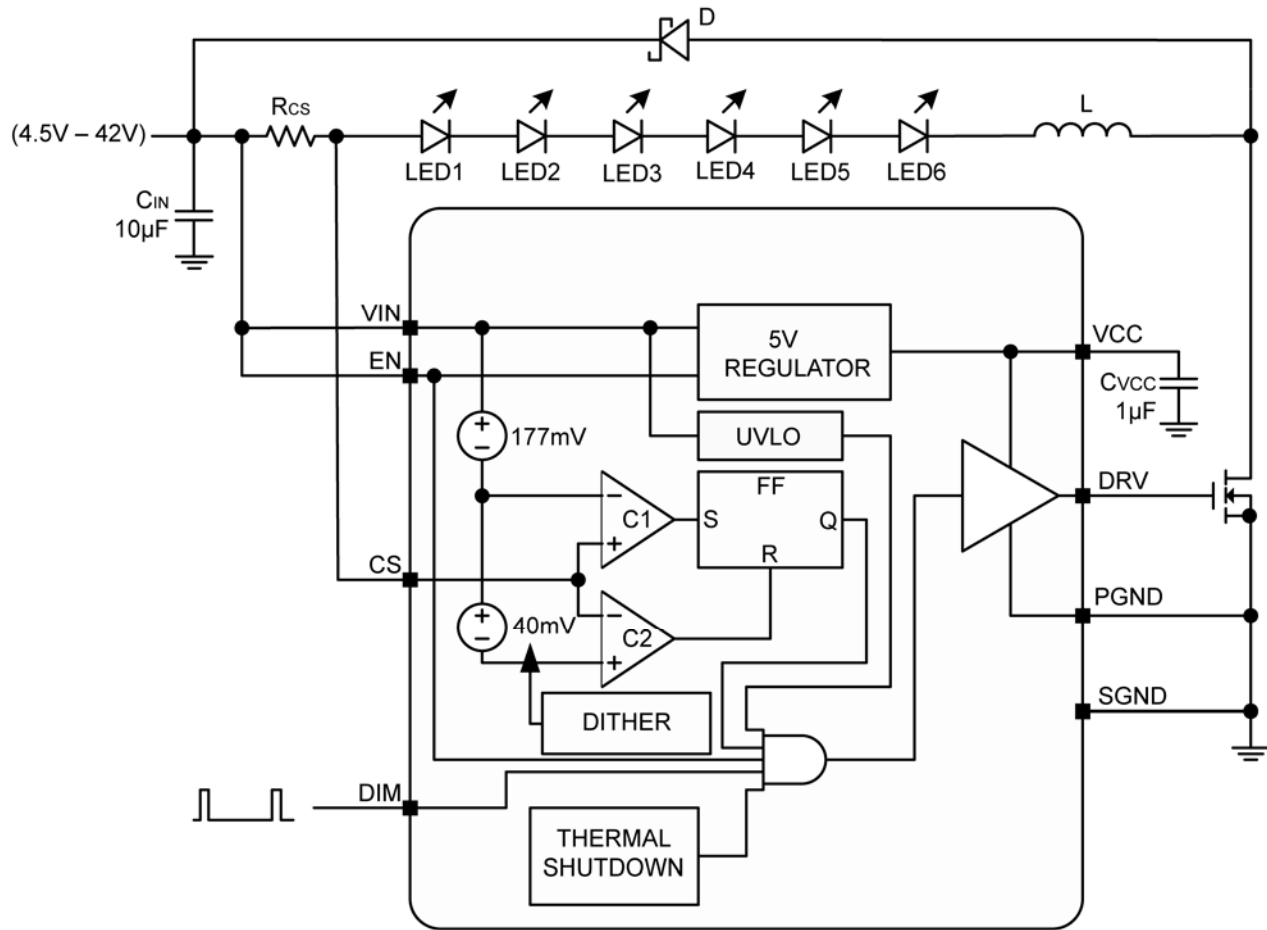

Figure 1. MAQ3203 Block Diagram

Functional Description

The MAQ3203 is a hysteretic step-down driver which regulates the LED current over wide input voltage range.

The device operates from a 4.5V to 42V input MOSFET voltage range and provides up to 0.5A source and 1A sink drive capability. When the input voltage reaches 4.5V, the internal 5V VCC is regulated and the DRV pin is pulled high to turn on an external MOSFET if EN pin and DIM pin are high. The inductor current builds up linearly. When the CS pin voltage hits the $V_{CS(MAX)}$ with respect to V_{IN} , the MOSFET turns off and the Schottky diode takes over and returns the current to V_{IN} . Then the current through inductor and LEDs starts decreasing. When CS pin hits $V_{CS(MIN)}$, the MOSFET turns on and the cycle repeats.

The frequency of operation depends upon input voltage, total LEDs voltage drop, LED current and temperature. The calculation for frequency of operation is given in application section.

The MAQ3203 has an on board **5V regulator which is for internal use only**. Connect a 1µF capacitor on VCC pin to analog ground.

The MAQ3203 has an EN pin which gives the flexibility to enable and disable the output with logic high and low signals.

The MAQ3203 also has a DIM pin which can turn on and off the LEDs if EN is in HIGH state. This DIM pin controls the brightness of the LED by varying the duty cycle of DIM pin from 1% to 99%.

Application Information

The internal block diagram of the MAQ3203 is shown in Figure 1. The MAQ3203 is composed of a current-sense comparator, voltage and current reference, 5V regulator and MOSFET driver. Hysteretic mode control – also called bang-bang control – is a topology that does not employ an error amplifier, using an error comparator instead.

The inductor current is controlled within a hysteretic window. If the inductor current is too small, the power MOSFET is turned on; if the inductor current is large enough, the power MOSFET is turned off. It is a simple control scheme with no oscillator and no loop compensation. Since the control scheme does not need loop compensation, it makes a design easy, and avoids problems of instability.

Transient response to load and line variation is very fast and only depends on propagation delay. This makes the control scheme very popular for certain applications.

LED Current and R_{CS}

The main feature in MAQ3203 is to control the LED current accurately within ±5% of set current. Choosing a high-side R_{CS} resistor helps for setting constant LED current irrespective of wide input voltage range. The following equation gives the R_{CS} value:

$$R_{CS} = \frac{1}{2} \times \left(\frac{V_{CS(MAX)} + V_{CS(MIN)}}{I_{LED}} \right)$$

Table 1. R_{CS} for LED Current

R _{CS} (Ω)	I _{LED} (A)	I ² R (W)	Size (SMD)
1.33	0.15	0.03	0603
0.56	0.35	0.07	0805
0.4	0.5	0.1	0805
0.28	0.7	0.137	0805
0.2	1.0	0.2	1206
0.13	1.5	0.3	1206
0.1	2.0	0.4	2010
0.08	2.5	0.5	2010
0.068	3.0	0.6	2010

For V_{CS(MAX)} and V_{CS(MIN)}, refer to the Electrical Characteristic table.

Frequency of Operation

To calculate the frequency spread across input supply:

$$V_L = L \frac{\Delta I_L}{\Delta t}$$

L is the inductance, ΔI_L is fixed (the value of the hysteresis):

$$\Delta I_L = \frac{V_{CS(MAX)} - V_{CS(MIN)}}{R_{CS}}$$

V_L is the voltage across inductor L which varies by supply.

For current rising (MOSFET is ON):

$$t_r = L \frac{\Delta I_L}{V_{L_RISE}}$$

where:

$$V_{L_RISE} = V_{IN} - I_{LED} \times R_{CS} - V_{LED}$$

For current falling (MOSFET is OFF):

$$t_f = L \frac{\Delta I_L}{V_{L_FALL}}$$

where:

$$V_{L_FALL} = V_D + I_{LED} \times R_{CS} + V_{LED}$$

$$T = t_r + t_f, F_{SW} = \frac{1}{T}$$

$$F_{SW} = \frac{(V_D + I_{LED} \times R_{CS} + V_{LED}) \times (V_{IN} - I_{LED} \times R_{CS} - V_{LED})}{L \times \Delta I_L \times (V_D + V_{IN})}$$

where :

- V_D is Schottky diode forward drop
- V_{LED} is total LEDs voltage drop
- V_{IN} is input voltage
- I_{LED} is average LED current

Inductor

According to the above equation, choose the inductor to make the operating frequency no higher than 1.5MHz. The following Tables give a reference inductor value and corresponding frequency for a given LED current. For space-sensitive applications, smaller inductor with higher switching frequency could be used but efficiency of the regular will be reduced.

Table 2. Inductor for VIN = 12V, 1 LED

RCS (Ω)	I _{LED} (A)	L (μH)	F _{SW} (kHz)
1.33	0.15	220	474
0.56	0.35	100	439
0.4	0.5	68	461
0.28	0.7	47	467
0.2	1.0	33	475
0.13	1.5	22	463
0.1	2.0	15	522
0.08	2.5	12	522
0.068	3.0	10	533

Table 3. Inductor for VIN = 24V, 4 LEDs

RCS (Ω)	I _{LED} (A)	L (μH)	F _{SW} (kHz)
1.33	0.15	470	474
0.56	0.35	220	426
0.4	0.5	150	447
0.28	0.7	100	470
0.2	1.0	68	493
0.13	1.5	47	463
0.1	2.0	33	507
0.08	2.5	27	496
0.068	3.0	22	517

Table 4. Inductor for VIN = 36V, 8 LEDs

RCS (Ω)	I _{LED} (A)	L (μH)	F _{SW} (kHz)
1.33	0.15	470	495
0.56	0.35	220	446
0.4	0.5	150	467
0.28	0.7	100	490
0.2	1.0	68	515
0.13	1.5	47	485
0.1	2.0	33	530
0.08	2.5	27	519
0.068	3.0	22	541

Given an inductor value, the size of the inductor can be determined by its RMS and peak current rating.

$$\frac{\Delta I_L}{I_L} = 2 \times \frac{V_{CS(MAX)} - V_{CS(MIN)}}{V_{CS(MAX)} + V_{CS(MIN)}} = 0.18$$

$$I_{L(RMS)} = \sqrt{I_L^2 + \frac{1}{12} \Delta I_L^2} \approx I_L$$

$$I_{L(PK)} = I_L + \frac{1}{2} \Delta I_L = 1.09 I_L$$

where:

I_L is inductor average current.

Select an inductor with saturation current rating at least 30% higher than the peak current.

MOSFET

MOSFET selection depends upon the maximum input voltage, output LED current and switching frequency.

The selected MOSFET should have 30% margin on maximum voltage rating for high reliability requirements.

The MOSFET channel resistance $R_{DS(ON)}$ is selected such that it helps to get the required efficiency at the required LED currents as well as meets the cost requirement.

Logic level MOSFETs are preferred as the drive voltage is limited to 5V.

The MOSFET power loss has to be calculated for proper operation. The power loss consists of conduction loss and switching loss. The conduction loss can be found by:

$$P_{LOSS(CON)} = I_{RMS(FET)}^2 \times R_{DS(ON)}$$

$$I_{RMS(FET)} = I_{LED} \times \sqrt{D}$$

$$D = \frac{V_{TOTAL_LED}}{V_{IN}}$$

The switching loss occurs during the MOSFET turn-on and turn-off transition and can be found by:

$$P_{\text{LOSS(TRAN)}} = \frac{V_{\text{IN}} \times I_{\text{LED}} \times F_{\text{SW}}}{I_{\text{DRV}}} \times (Q_{\text{gs2}} + Q_{\text{gd}})$$

$$I_{\text{DRV}} = \frac{V_{\text{DRV}}}{R_{\text{GATE}}}$$

where:

R_{GATE} is total MOSFET resistance, Q_{gs2} and Q_{gd} can be found in a MOSFET manufacturer datasheet.

The total power loss is:

$$P_{\text{LOSS(TOT)}} = P_{\text{LOSS(CON)}} + P_{\text{LOSS(TRAN)}}$$

The MOSFET junction temperature is given by:

$$T_{\text{J}} = P_{\text{LOSS(TOT)}} \times R_{\theta\text{JA}} + T_{\text{A}}$$

The T_{J} must not exceed maximum junction temperature under any conditions.

Snubber

A RC voltage snubber is used to damp out high frequency ringing on the switch node caused by parasitic inductance and capacitance. The capacitor is used to slow down the switch node rise and fall time and the resistor damps the ringing. Excessive ringing can cause the MAQ3203 to operate erratically by prematurely tripping its current limit comparator circuitry.

The snubber is connected across the Schottky diode as shown in the evaluation board schematic. Capacitor C_{S} (C4) is used to block the DC voltage across the resistor, minimizing the power dissipation in the resistor. This capacitor value should be between two to five times the parasitic capacitance of the MOSFET C_{OSS} and the Schottky diode junction capacitance C_{j} . A capacitor that is too small will have high impedance and prevent the resistor from damping the ringing. A capacitor that is too large causes unnecessary power dissipation in the resistor, which lowers efficiency.

The snubber components should be placed as close as possible to the Schottky diode. Placing the snubber too far from the diode or using an etch that is too long or too thin adds inductance to the snubber and diminishes its effectiveness.

Proper snubber design requires the parasitic inductance and capacitance be known. A method of determining these values and calculating the damping resistor value is outlined below:

1. Measure the ringing frequency at the switch node which is determined by parasitic L_{P} and C_{P} . Define this frequency as f_1 .
2. Add a capacitor C_{S} (normally at least 3 times as big as the C_{OSS} of the diode) across the diode and measure the new ringing frequency. Define this new (lower) frequency as f_2 . L_{P} and C_{P} can now be solved using the values of f_1 , f_2 and C_{S} .
3. Add a resistor R_{S} in series with C_{S} to generate critical damping. If the snubber resistance is equal to the characteristic impedance of the resonant circuit ($1/\sqrt{\text{L}_{\text{P}}\text{C}_{\text{P}}}$), the resonant circuit will be critically damped and have no ringing.

Step 1: First measure the ringing frequency on the switch node voltage when the high-side MOSFET turns on. This ringing is characterized by the equation:

$$f_1 = \frac{1}{2\pi\sqrt{L_{\text{P}} \times C_{\text{P}}}}$$

where:

C_{P} and L_{P} are the parasitic capacitance and inductance.

Step 2: Add a capacitor, C_{S} , in parallel with the Schottky diode. The capacitor value should be approximately 3 times the C_{OSS} of D1. Measure the frequency of the switch node ringing, f_2 .

$$f_2 = \frac{1}{2\pi\sqrt{L_{\text{P}} \times (C_{\text{S}} + C_{\text{P}})}}$$

Define f' as:

$$f' = \frac{f_1}{f_2}$$

Combining the equations for f_1 , f_2 and f' to derive C_{P} , the parasitic capacitance:

$$\left(C_{\text{P}} = \frac{C_{\text{S}}}{2 \times (f')^2 - 1} \right)$$

L_P is solved by re-arranging the equation for f_1 :

$$L_P = \frac{1}{(2\pi)^2 \times C_P \times (f_1)^2}$$

Step 3: Calculate the damping resistor. Critical damping occurs at $Q = 1$:

$$Q = \frac{1}{R_S} \sqrt{\frac{L_P}{C_S + C_P}} = 1$$

Solving for R_S :

$$R_S = \sqrt{\frac{L_P}{C_S + C_P}}$$

The snubber capacitor, C_S , is charged and discharged each switching cycle. The energy stored in C_S is dissipated by the snubber resistor, R_S , two times per switching period. This power is calculated in the equation below:

$$P_{\text{SNUBBER}} = f_S \times C_S \times V_{\text{IN}}^2$$

where:

f_S is the switching frequency for each phase. V_{IN} is the DC input voltage.

An alternate method to reduce the switch node ringing is to place a 2.2Ω resistor in series with the n-channel MOSFET's gate pin. This will slow down both the rising and falling edge of the switch node waveform.

Freewheeling Diode

The diode provides a conduction path for the inductor current during the switch off time. The reverse voltage rating of the diode should be at least 1.2 times the maximum input voltage. A Schottky diode is recommended for highest efficiency.

The Schottky diode can be the major source of power loss, especially at the maximum input voltage. The current through the diode is equal to the LED current with a duty cycle of $(V_{\text{IN}} - V_{\text{LED}})/V_{\text{IN}}$.

The diode dissipation is given by:

$$P_D = I_{\text{LED}} \times \frac{(V_{\text{IN}} - V_{\text{LED}})}{V_{\text{IN}}} \times V_f$$

V_f is the forward voltage of the diode at I_{LED} . A Schottky diode forward voltage is typically 0.6V at its full rated current. It is normal design practice to use a diode rated at 1.5 to 2 times output current to maintain efficiency. This derating allows V_f to drop to approximately 0.5V. When calculating the "worst case" power dissipation, use the maximum input voltage and the actual diode forward voltage drop at the maximum operating temperature; otherwise the calculated power dissipation will be artificially high. The forward voltage drop of a diode decreases as ambient temperature is increased, at a rate of $-1.0\text{mV}/^\circ\text{C}$.

Input Capacitor

The ceramic input capacitor is selected by voltage rating and ripple current rating. To determine the input current ripple rating, the RMS value of the input capacitor can be found by:

$$I_{\text{CIN(RMS)}} = I_{\text{LED}} \times \sqrt{D \times (1-D)}$$

The power loss in the input capacitor is:

$$P_{\text{LOSS(CIN)}} = I_{\text{CIN(RMS)}}^2 \times C_{\text{IN(ESR)}}$$

The input capacitor current rating can be considered as $I_{\text{LED}}/2$ under the worst condition $D = 50\%$.

LED Ripple Current

The LED current is the same as inductor current. If LED ripple current needs to be reduced then place a $4.7\mu\text{F}/50\text{V}$ ceramic capacitor across LED.

Frequency Dithering

The MAQ3203 is designed to reduce EMI by dithering the switching frequency $\pm 12\%$ in order to spread the frequency spectrum over a wider range. This lowers the EMI noise peaks (see Figure 2) generated by the switching regulator.

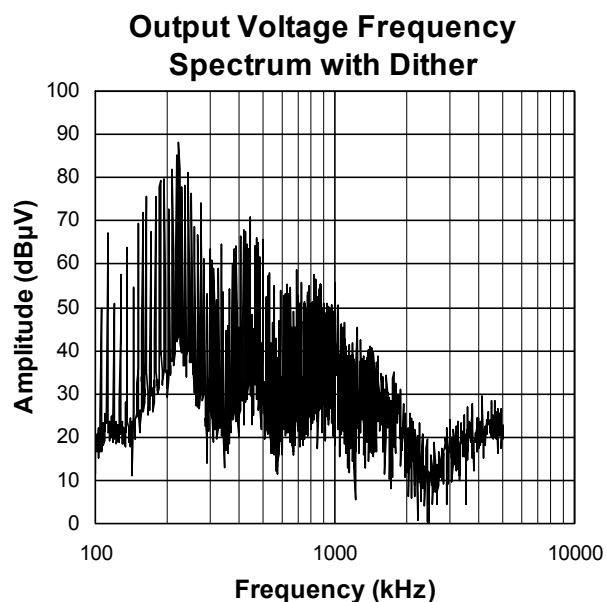

Figure 2. Output Voltage Frequency Spectrum without Dither

Switching regulators generate noise by their nature and they are the main EMI source to interference with nearby circuits. If the switching frequency of a regulator is modulated via frequency dithering, the energy of the EMI is spread among many frequencies instead of concentrated at fundamental switching frequency and its harmonics. The MAQ3203 modulates the $V_{CS(MAX)}$ with amplitude $\pm 6mV$ by a pseudo random generator to generate the $\pm 12\%$ of the switching frequency dithering to reduce the EMI noise peaks.

PCB Layout Guidelines

Warning!!! To minimize EMI and output noise, follow these layout recommendations.

PCB Layout is critical to achieve reliable, stable and efficient performance. A ground plane is required to control EMI and minimize the inductance in power, signal and return paths.

The following guidelines should be followed to insure proper operation of the MAQ3203 regulator.

IC

Use thick traces to route the input and output power lines.

Signal and power grounds should be kept separate and connected at only one location.

Input Capacitor

Place the input capacitors on the same side of the board and as close to the IC as possible.

Keep both the VIN and PGND traces as short as possible.

Place several vias to the ground plane close to the input capacitor ground terminal, but not between the input capacitors and IC pins.

Use either X7R or X5R dielectric input capacitors. Do not use Y5V or Z5U type capacitors.

Do not replace the ceramic input capacitor with any other type of capacitor. Any type of capacitor can be placed in parallel with the input capacitor.

If a Tantalum input capacitor is placed in parallel with the input capacitor, it must be recommended for switching regulator applications and the operating voltage must be derated by 50%.

In "Hot-Plug" applications, a Tantalum or Electrolytic bypass capacitor must be placed in parallel to ceramic capacitor to limit the over-voltage spike seen on the input supply with power is suddenly applied. In this case an additional Tantalum or Electrolytic bypass input capacitor of 22 μ F or higher is required at the input power connection if necessary.

Inductor

Keep the inductor connection to the switch node (MOSFET drain) short.

Do not route any digital lines underneath or close to the inductor.

To minimize noise, place a ground plane underneath the inductor.

Output Capacitor

If LED ripple current needs to be reduced then place a 4.7 μ F/50V capacitor across LED. The capacitor must be placed as close to the LED as possible.

MOSFET

Place the MOSFET as close as possible to the MAQ3203 to avoid the trace inductance. Provide sufficient copper area on MOSFET ground to dissipate the heat.

Diode

Place the Schottky diode on the same side of the board as the IC and input capacitor.

The connection from the Schottky diode's Anode to the switching node must be as short as possible.

The diode's Cathode connection to the R_{CS} must be kept as short as possible.

RC Snubber

If a RC snubber is needed, place the RC snubber on the same side of the board and as close to the Schottky diode as possible.

R_{CS} (Current-Sense Resistor)

VIN pin and CS pin must be as close as possible to R_{CS}. Make a Kelvin connection to the VIN and CS pin respectively for current sensing.

Trace Routing Recommendation

Keep the power traces as short and wide as possible. One current flowing loop is during the MOSFET ON time, the traces connecting the input capacitor C_{IN}, R_{CS}, LEDs, Inductor, the MOSFET and back to C_{IN}. The other current flowing loop is during the MOSFET OFF time, the traces connecting R_{CS}, LED, inductor, free wheeling diode and back to R_{CS}. These two loop areas should be kept as small as possible to minimize the noise interference,

Keep all analog signal traces away from the switching node and its connecting traces.

Ripple Measurements

To properly measure ripple on either input or output of a switching regulator, a proper ring in tip measurement is required. Standard oscilloscope probes come with a grounding clip, or a long wire with an alligator clip. Unfortunately, for high-frequency measurements, this ground clip can pick-up high-frequency noise and erroneously inject it into the measured output ripple.

The standard evaluation board accommodates a home made version by providing probe points for both the input and output supplies and their respective grounds. This requires the removing of the oscilloscope probe sheath and ground clip from a standard oscilloscope probe and wrapping a non-shielded bus wire around the oscilloscope probe. If there does not happen to be any non-shielded bus wire immediately available, the leads from axial resistors will work. By maintaining the shortest possible ground lengths on the oscilloscope probe, true ripple measurements can be obtained.

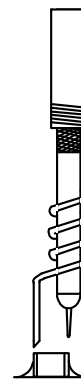
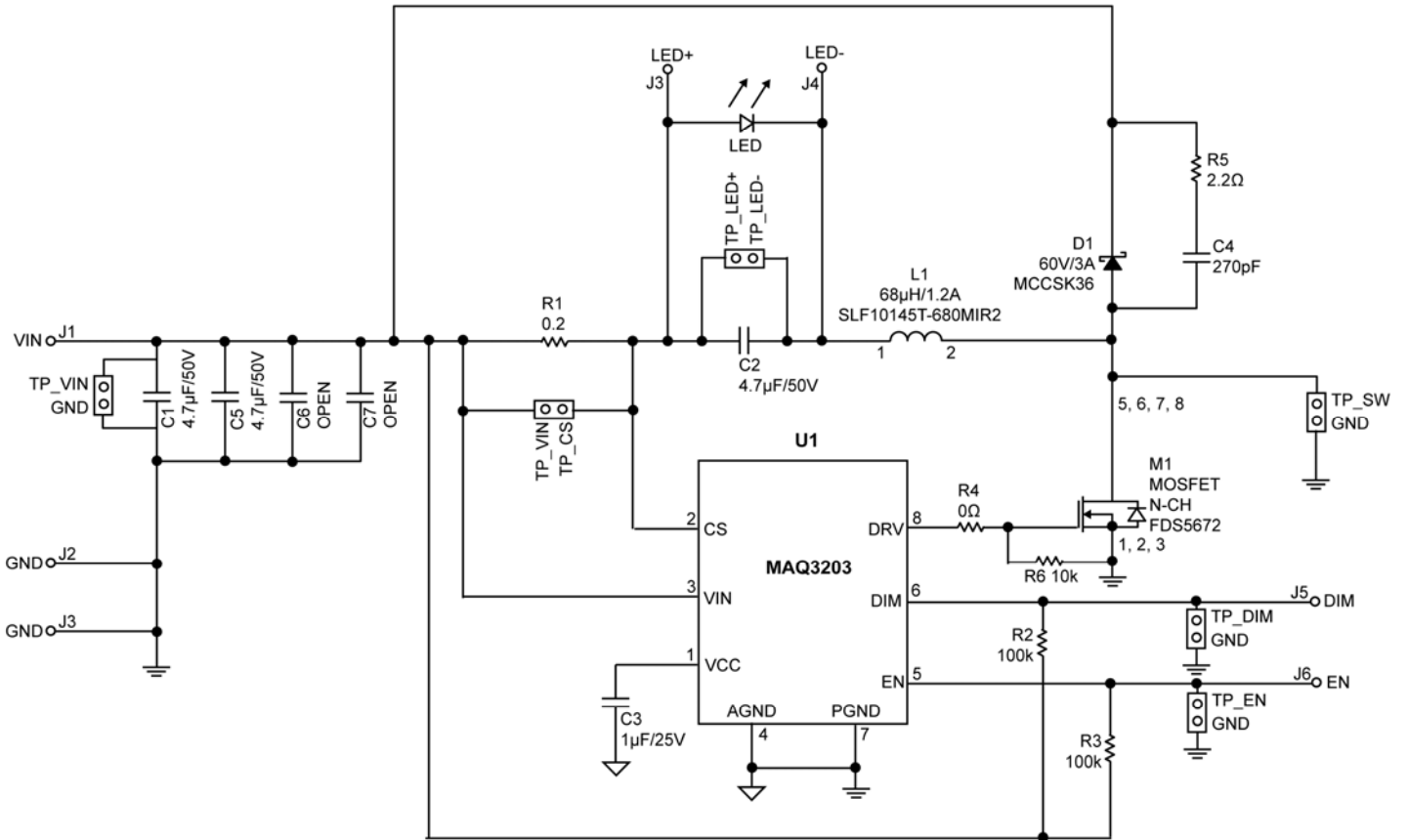

Figure 3. Low Noise Measurement

Evaluation Board Schematic



www.DataSheet4U.com

Bill of Materials

Item	Part Number	Manufacturer	Description	Qty.
C1, C5	12105C475KAZ2A	AVX ⁽¹⁾	4.7µF/50V, Ceramic Capacitor, X7R, Size 1210	2
	GRM32ER71H475KA88L	Murata ⁽²⁾		
C2	12105C475KAZ2A	AVX ⁽¹⁾	4.7µF/50V, Ceramic Capacitor, X5R, Size 1210	1
	GRM32ER71H475KA88L	Murata ⁽²⁾		
	C3225X7S1H475M	TDK ⁽³⁾		
C3	08053D105KAT2A	AVX ⁽¹⁾	1µF/25V, Ceramic Capacitor, X5R, Size 0805	1
	GRM21BR71E105KA99L	Murata ⁽²⁾	1µF/25V, Ceramic Capacitor, X7R, Size 0805	1
	C2012X7R1E105K	TDK ⁽³⁾		
C4	(Open) 08055A271JAT2A	AVX ⁽¹⁾	270pF/50V, Ceramic Capacitor NPO, Size 0805	1
	(Open) GRM2165C2A271JA01D	Murata ⁽²⁾		
D1	SK36-TP	MCC ⁽⁴⁾	60V, 3A, SMC, Schottky Diode	1
	SK36	Fairchild ⁽⁵⁾		
	SK36-7-F	Diodes, Inc. ⁽⁶⁾		
L1	SLF10145T-680M1R2	TDK ⁽³⁾	68µH, 1.2A, 0.14Ω, SMT, Power Inductor	1
M1	FDS5672	Fairchild ⁽⁷⁾	MOSFET, N-CH, 60V, 12A, SO-8	1
R1	CSR 1/2 0.2 1% I	Stackpole Electronics, Inc ⁽⁸⁾	0.2Ω Resistor, 1/2W, 1%, Size 1206	1
R2, R3	CRCW08051003FKEA	Vishay ⁽⁹⁾	100kΩ Resistor, 1% , Size 0805	2
R4	CRCW08050000FKEA	Vishay ⁽⁹⁾	0Ω Resistor, 1%, Size 0805	1
R5	(Open) CRCW08052R20FKEA	Vishay ⁽⁹⁾	2.2Ω Resistor, 1%, Size 0805	1
R6	CRCW08051002FKEA	Vishay ⁽⁹⁾	10kΩ Resistor, 1% , Size 0805	1
U1	MAQ3203YM	Micrel, Inc. ⁽¹⁰⁾	High-Brightness LED Driver Controller with High-Side Current Sense	1

Notes:

1. AVX: www.avx.com.
2. Murata: www.murata.com.
3. TDK: www.tdk.com.
4. MCC: www.mccsemi.com.
5. Fairchild: www.fairchildsemi.com.
6. Diodes Inc. : www.diodes.com.
7. Fairchild : www.Fairchildsemi.com.
8. Stackpole Electronics: www.seielect.com.
9. Vishay: www.vishay.com.
10. Diodes Inc. : www.diodes.com.
11. Micrel, Inc.: www.micrel.com.

PCB Layout Recommendation

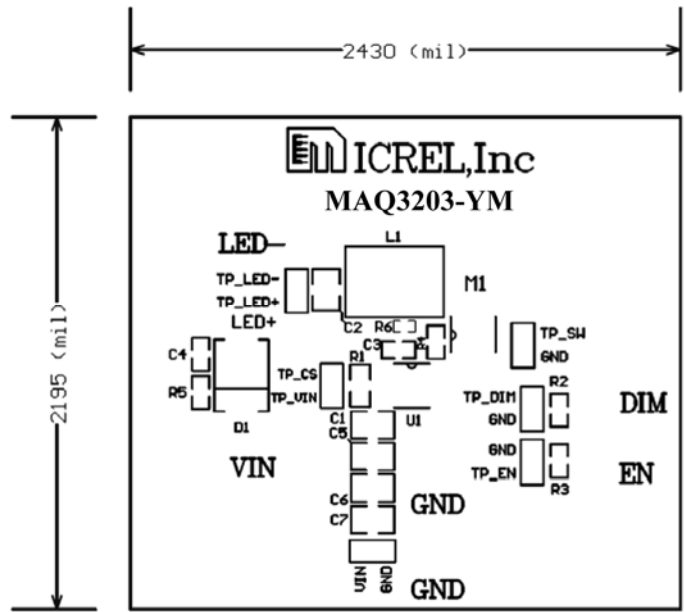

Top Assembly

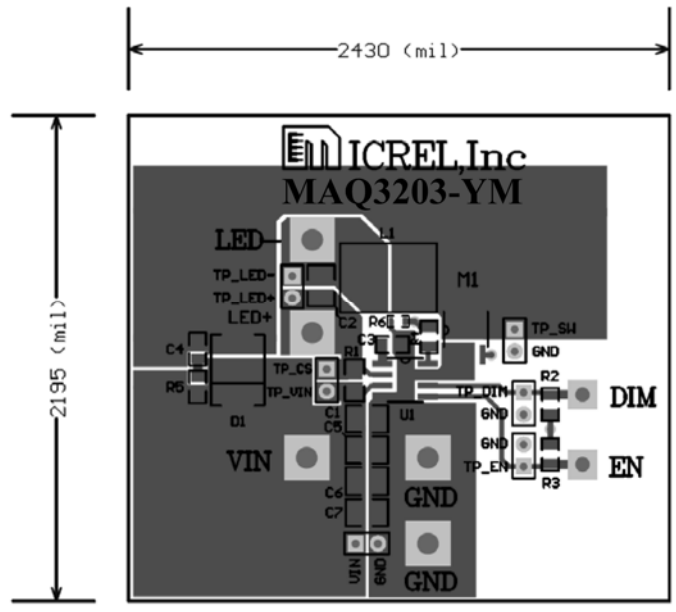

Top Layer

www.DataSheet4U.com

PCB Layout Recommendation (Continued)

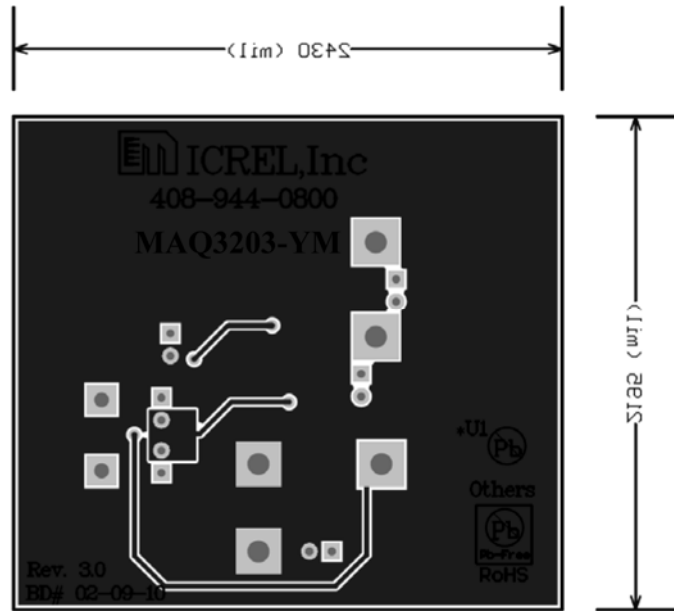

Bottom Layer

Package Information

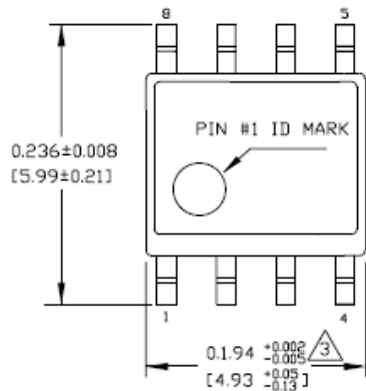

TOP VIEW

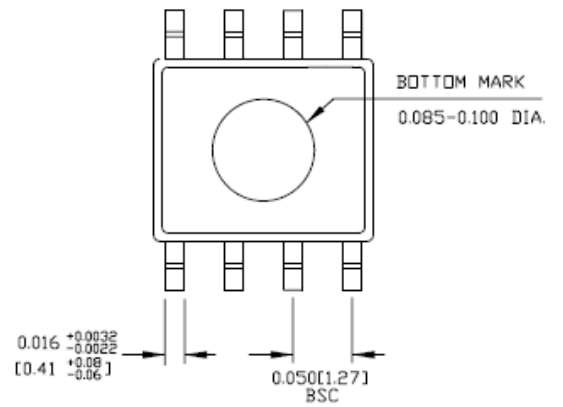

BOTTOM VIEW

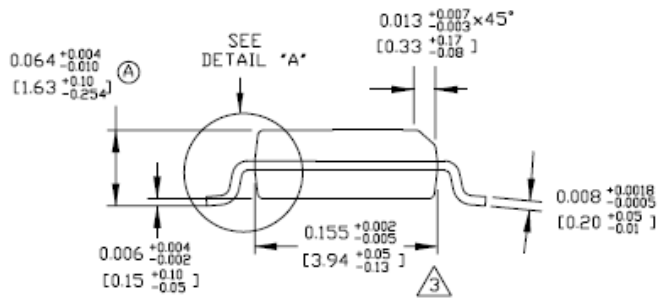

END VIEW

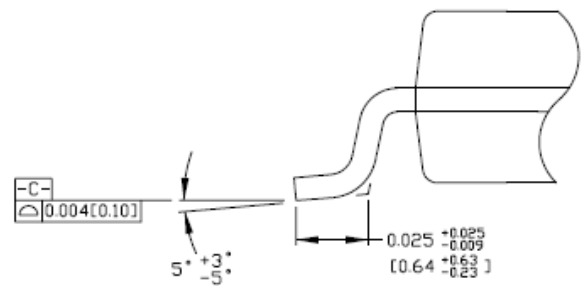

DETAIL *A*

8-Pin SOIC

Recommended Landing Pattern

LP # **SOICN-8LD-LP-1**
 All units are in mm
 Tolerance ± 0.05 if not noted

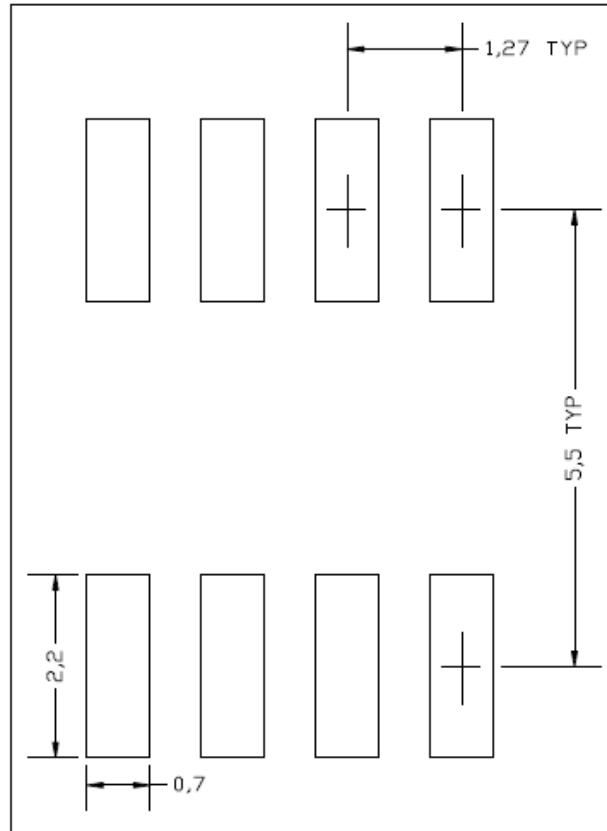

8-Pin SOIC

MICREL, INC. 2180 FORTUNE DRIVE SAN JOSE, CA 95131 USA
 TEL +1 (408) 944-0800 FAX +1 (408) 474-1000 WEB <http://www.micrel.com>

Micrel makes no representations or warranties with respect to the accuracy or completeness of the information furnished in this data sheet. This information is not intended as a warranty and Micrel does not assume responsibility for its use. Micrel reserves the right to change circuitry, specifications and descriptions at any time without notice. No license, whether express, implied, arising by estoppel or otherwise, to any intellectual property rights is granted by this document. Except as provided in Micrel's terms and conditions of sale for such products, Micrel assumes no liability whatsoever, and Micrel disclaims any express or implied warranty relating to the sale and/or use of Micrel products including liability or warranties relating to fitness for a particular purpose, merchantability, or infringement of any patent, copyright or other intellectual property right

Micrel Products are not designed or authorized for use as components in life support appliances, devices or systems where malfunction of a product can reasonably be expected to result in personal injury. Life support devices or systems are devices or systems that (a) are intended for surgical implant into the body or (b) support or sustain life, and whose failure to perform can be reasonably expected to result in a significant injury to the user. A Purchaser's use or sale of Micrel Products for use in life support appliances, devices or systems is a Purchaser's own risk and Purchaser agrees to fully indemnify Micrel for any damages resulting from such use or sale.

© 2011 Micrel, Incorporated.